

PURE

Evoke H3



Evoke H3

EN

DE

FR

IT

NO
DA

NL

Thank you for choosing the Evoke H3. This user manual explains how to use the various features of your Evoke H3. If you need more help, you can view our help topics at support.pure.com.

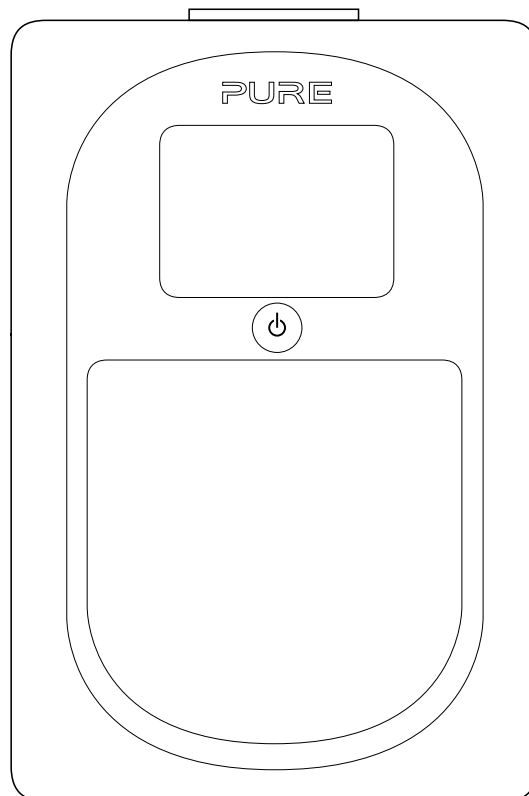



Contents

Evoke H3	1	Bluetooth and auxiliary devices	11
Safety	4	Connecting a Bluetooth device	11
Getting started	5	Connecting a device with an auxiliary cable	12
Your Evoke	5	Alarms	12
Setting up your Evoke H3	6	Setting an alarm	12
Switching your Evoke H3 on and off	7	Cancelling an existing alarm	13
Changing the volume	7	Snoozing or silencing an alarm	14
Digital radio	8	Timers	14
Listening to digital radio	8	Setting the kitchen timer	14
Changing the digital radio station	8	Silencing the kitchen timer	15
Automatically tuning to digital radio stations	9	Setting the sleep timer	15
FM radio	9	Settings	16
Listening to FM radio	9	Personalising the sound on your Evoke H3	16
Changing the FM radio station	9	Display settings	16
Changing the scan settings for FM radio	9	Clock settings	17
Choosing stereo or mono reception for FM radio	10	Changing the language	18
Radio station presets	10	Resetting to factory settings	19
About presets	10	Updating the software	19
Storing a radio station as a preset	10	Using a ChargePAK	20
Listening to a preset	11	About ChargePAKs	20
		Inserting a ChargePAK	20
		Troubleshooting	21
		Specifications	22

Safety

Safety instructions and cautions

Symbols used on this product

Symbol	Description
	This symbol is used on the product to indicate a caution and that instructions should be read before use.
	This symbol indicates DC voltage.
	This symbol indicates where the product is switched on or put into standby.

1. Read, heed and retain these instructions – All the safety and operating instructions should be read before this product is used and retained for future reference. All warnings on the appliance and in the operating instructions should be followed
2. Failure to install or use the product in accordance with these instructions may impair the safety of the product and invalid the warranty.
3. Use only power supply listed in these user manual/user instructions (supplied by Pure with model number SW0551000-AM) to power the equipment and do not use the power supply for any other purpose.
4. The direct plug-in adapter is used as a disconnect device, the disconnect device shall remain readily operable and accessible.
5. Do not immerse in water or use in a wet / moist environment, such as in the shower or bathroom if plugged into the mains supply. The power supply shall not be exposed to dripping or splashing and no objects filled with liquids, such as vases, placed above it.
6. Do not remove screws from or open the product casing.
7. Keep the product away from direct sunlight and from heat sources such as radiators, heaters or other appliances that produce heat.
8. Danger of explosion if the battery is incorrectly replaced (ensure correct polarity). Replace only with the same or equivalent type. The battery shall not be exposed to excessive heat such as sunshine, fire or similar. Attention is drawn to the environmental aspects of battery disposal. **See Section - “Using a ChargePAK”**
9. Do not expose the product to naked flame sources, such lighted candles which should not be placed on or near the product.
10. Ventilation should not be impaired by covering the product or power supply.
11. Clean only with a dry cloth.
12. This product is intended for use in moderate climates.
13. If the product is used in a manner not specified by the instructions, the product’s protection could be impaired.
14. Do not use the product if any damage is noticed.
15. Product repairs are only allowed to be carried out by competent and authorised personnel.

Getting started

Your Evoke

Front controls

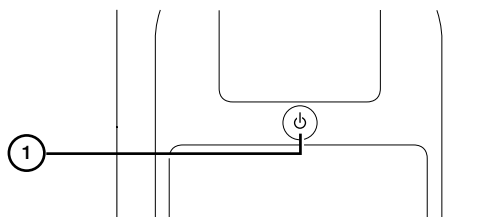

1 Standby

Switch your Evoke H3 on and off, or put it in standby

Top controls

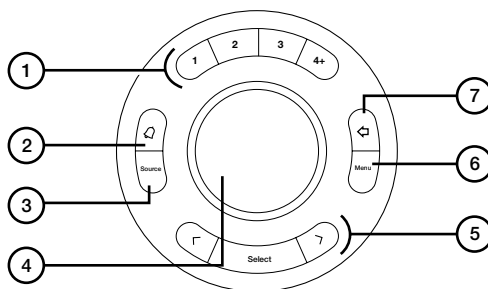

1 Presets

Press to store and access your favourite radio stations

2 Alarm

Press to set an alarm, a kitchen timer or a sleep timer

3 Source

Press to change between digital radio, FM radio, Bluetooth, and auxiliary input

4 Volume/Scroll

Turn to change the volume, press to mute the volume

Tip: When you are in a menu, you can turn and press the Volume dial to choose settings and options. To then use the dial to change the volume again, wait 10 seconds or press ↩.

5 Select

Press to browse radio stations, or choose settings and options

6 Menu

Press to change settings and options

7 Back

Press when in the menu to go back to the previous screen

Rear connections

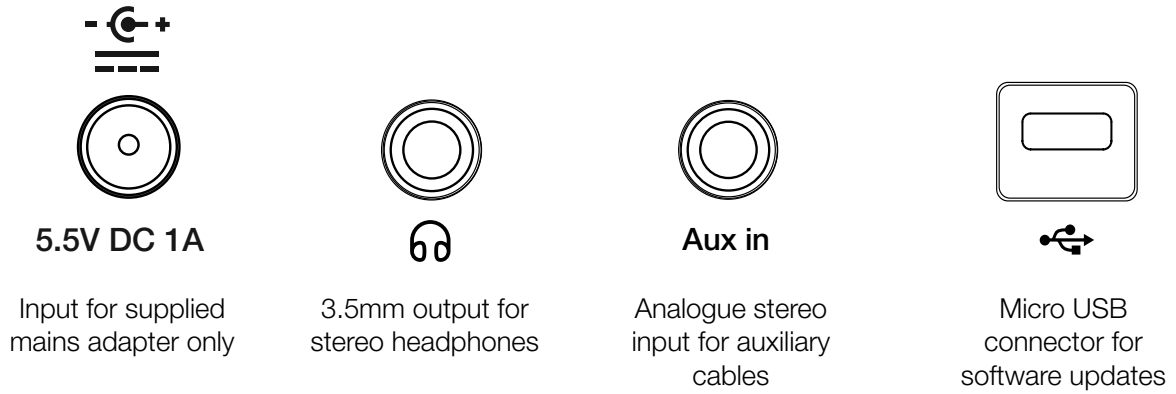

Setting up your Evoke H3

To set up your Evoke H3:

1. Unclip the aerial and fully extend it.
2. Connect the supplied mains adapter to the input on the back of your Evoke H3.
3. Plug the mains adapter into the mains supply.

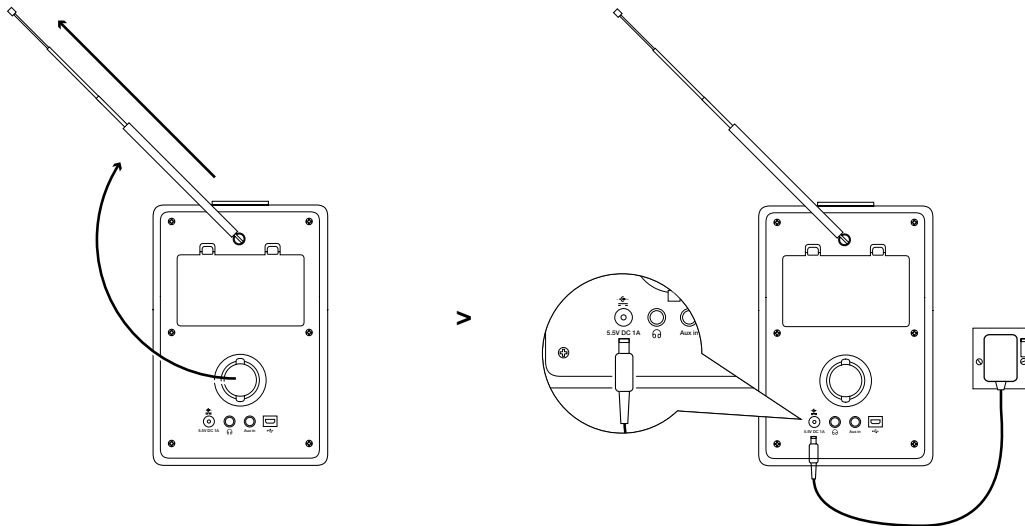

Switching your Evoke H3 on and off

If you have a ChargePAK rechargeable battery, insert it before you switch your Evoke H3 on. Read more about using a ChargePAK on page 20.

To switch your Evoke H3 on:

- Press .

Note: When you switch your Evoke H3 on for the first time, it starts tuning to digital radio stations. After the autotune is complete, you can start listening to digital radio.

To switch your Evoke H3 off or put it in standby:

- Press .

If your Evoke H3 is being powered by a ChargePAK, your Evoke H3 switches off. If your Evoke H3 is connected to a power socket, your Evoke H3 enters standby. In standby, your Evoke H3 uses a low amount of power and displays the time and date on the screen.

Changing the volume

To change the volume:

- To increase the volume, turn the Volume dial clockwise.
- To decrease the volume, turn the Volume dial anticlockwise.

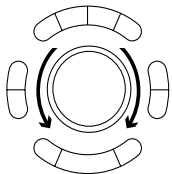

To mute the volume:

- Press the Volume dial.

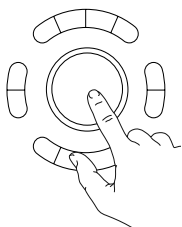

Digital radio



Listening to digital radio

To listen to digital radio:

- Press  until 'Digital Radio' is displayed.
Tip: Some digital radio stations also broadcast information and graphics, such as music album artwork or weather updates. Press and hold the **Select** button to change between slideshow, large slideshow and display modes.

Changing the digital radio station

To change the digital radio station:

1. Press  or  to browse through the available radio stations.
2. Press  to change radio station.

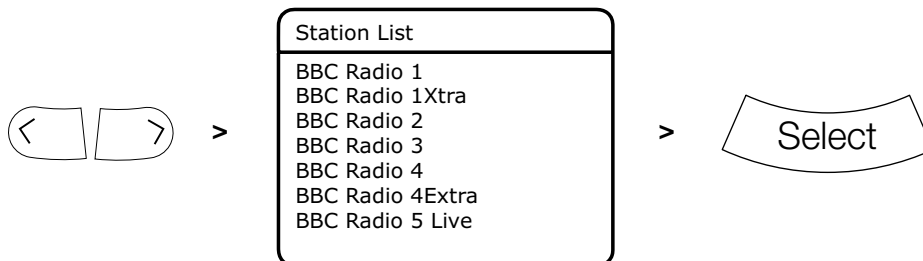

Tip: A '>>' next to a radio station name means the station has a secondary service, which provides more content. The secondary service is listed below the radio station with a '<<' next to the service name. Secondary services may only be available at certain times.
A '?' next to a radio station name means the station is inactive or unavailable.

Automatically tuning to digital radio stations

When you switch your Evoke H3 on for the first time, it automatically scans for digital radio stations. If you move your Evoke H3 to a new location, perform an autotune to update the list of radio stations.

To automatically tune to digital radio stations:

1. Press .
2. Press the **Select** buttons to choose 'Autotune'.
Your Evoke H3 starts scanning for digital radio stations.

FM radio





Listening to FM radio

To listen to FM radio:

- Press  until 'FM' is displayed.

Changing the FM radio station

To change the FM radio station:

- To scan to the previous or next radio station, press and hold  or .
 - To manually tune to a radio station, press  or .
- The frequency steps up or down by 0.05 MHz.

Changing the scan settings for FM radio

When you scan for FM radio stations, you can include all radio stations or only those with a strong signal.

To change scan settings for FM radio:

1. Press .
2. Press the **Select** buttons to choose 'Scan Setting'.
3. Press the **Select** buttons to choose 'Strong Stations Only' or 'All Stations'.

Choosing stereo or mono reception for FM radio

By default, your Evoke H3 uses stereo reception for FM radio. If your FM radio stations have a weak signal, try using mono reception to improve the signal strength.



To choose stereo or mono reception:

1. Press .
2. Press the **Select** buttons to choose 'Stereo'.
3. Press the **Select** buttons to choose 'FM Stereo' or 'Forced Mono'.

Radio station presets

About presets



You can store your favourite radio stations as presets. You can use presets to quickly tune to your stored radio stations whenever you want.

On the top of your Evoke H3, there are four preset buttons. Use  to  for quick access to your favourite radio stations. Use  to open a list of all your presets.



You can store up to 20 digital radio stations and up to 20 FM radio stations as presets.

Storing a radio station as a preset

To store a radio station to a preset from 1 to 3:

1. Tune to the radio station you want to store.
2. Choose a preset button from  to  then press and hold it until a  is displayed.
Tip: If there is already a radio station stored to the preset you've selected, the new station replaces it.

To store a radio station to the preset list:

1. Tune to the radio station you want to store.
2. Press and hold  until the preset list is displayed.
3. Press the **Select** buttons to choose a preset number. A  is displayed.
Tip: If there is already a radio station stored to the preset you've selected, the new station replaces it.

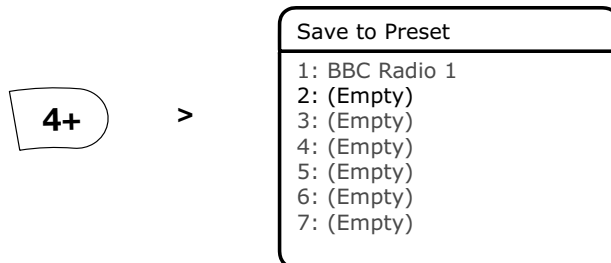

Listening to a preset

To listen to a preset from 1 to 3:

- Press a preset button from to . For example, to listen to the radio station stored as preset 2, press .

To listen to any preset:

- Press to open the preset list.
- Press the **Select** buttons to choose a preset.

Bluetooth and auxiliary devices

Connecting a Bluetooth device

You can use Bluetooth to wirelessly connect to a device, such as a mobile phone or tablet. You can then stream music from your mobile phone or tablet through your Evoke H3.

The first time you connect a Bluetooth device to your Evoke H3, you need to pair them. After you've paired a device with your Evoke H3, your Evoke H3 remembers it for the next time.

To connect a Bluetooth device:

- Press until 'Bluetooth' is displayed.
- On your Bluetooth device, switch Bluetooth on and connect to your Evoke H3.

Note: For more information, see your Bluetooth device's user manual. If you are asked to enter a passcode, enter 0000.

When 'Connected' is displayed on your Evoke H3 screen, your Evoke H3 is ready to stream music.

Tip: If you want to connect a different Bluetooth device to your Evoke H3, switch off Bluetooth on the connected device first.

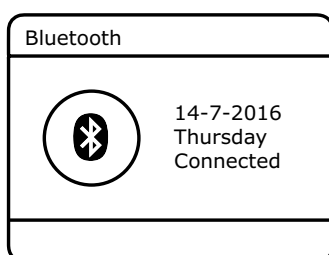

Connecting a device with an auxiliary cable

You can use an auxiliary cable to connect a device, such as an MP3 player, to your Evoke H3. You can then enjoy music saved on the device through your Evoke H3.

To connect a device with an auxiliary cable:

1. Press  until 'Auxiliary Input' is displayed.
2. Insert an auxiliary cable into the **Aux in** socket on the back of your Evoke H3.
3. Insert the other end of the auxiliary cable into the device you want to connect.
Your Evoke H3 is now ready to play music from the connected device.

Alarms

To wake up to your favourite radio station, you can set up to two alarms on your Evoke H3.



Note: You cannot set alarms when your Evoke H3 is being powered by a ChargePAK.

Setting an alarm

To set an alarm:

1. Press .
2. Press the **Select** buttons to choose 'Alarm 1' or 'Alarm 2'.
3. Press the **Select** buttons to change settings for the alarm.

'Alarm'	Turn the alarm on or off
'Frequency'	Choose how often you want the alarm to sound
'Wake Up time'	Choose the time for the alarm
'Source'	Choose to wake up to an FM or digital radio station, or a buzzer Tip: To choose FM or digital radio, you need to have stored a radio station as a preset.
'Preset'	Choose a radio station to wake up to Tip: If you do not choose a preset, the default setting is the radio station that you last listened to.
'Duration'	Choose how many minutes the alarm sounds for
'Volume'	Choose the volume for the alarm

4. When you have made all of your changes, press  to exit the menu.
The  or  symbol is displayed at the bottom of the screen when an alarm is set.

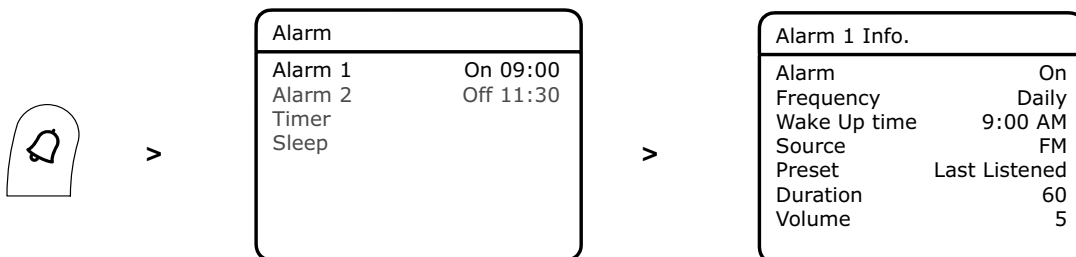

Cancelling an existing alarm

To cancel an existing alarm:

1. Press .
2. Press the **Select** buttons to choose 'Alarm 1' or 'Alarm 2'.
3. Press the **Select** buttons to change the 'Alarm' setting to 'Off'.

Snoozing or silencing an alarm

To snooze an alarm:

- Press the **Select** button or the Volume dial.
The alarm snoozes for 5 minutes.
Tip: For a longer snooze, press the **Select** button multiple times.

To silence an alarm:





- Press .

Timers

Setting the kitchen timer

The kitchen timer counts down and then ends with an alarm tone.

To set the kitchen timer:

1. Press .
2. Press the **Select** buttons to choose 'Timer'.
3. Press  or  to choose the duration of the timer.
4. Press  to start the timer.

The  symbol is displayed at the bottom of the screen when the timer is set.

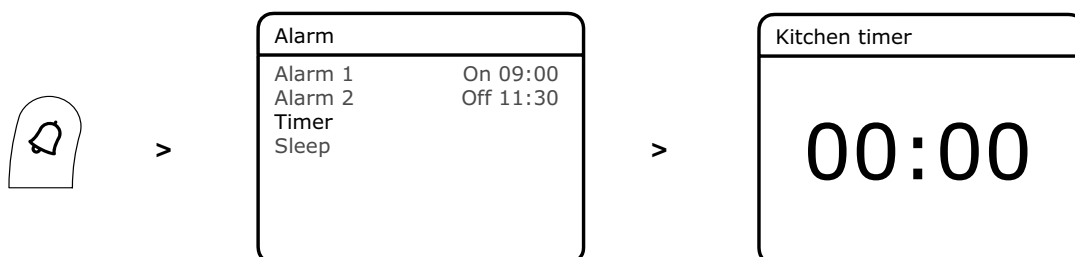

Silencing the kitchen timer





To silence the kitchen timer:

- Press .

Setting the sleep timer

The sleep timer puts your Evoke H3 in standby after a set amount of time.

To set the sleep timer:

1. Press .
2. Press the **Select** buttons to choose 'Sleep'.
3. Press  or  to choose the duration of the timer.
Tip: You can choose between 15 and 90 minutes.
4. Press  to start the timer.

The  symbol and remaining time is displayed at the bottom of the screen when the timer is set.

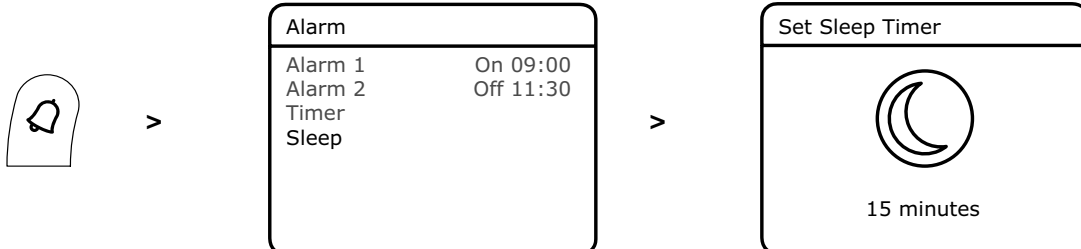

Settings

Personalising the sound on your Evoke H3

Use the equaliser setting to get the most out of your music. There are several equaliser settings set up already. For example, to hear classical music at its best, change the equaliser setting to 'Classic'. You can also customise the equaliser to change the treble, bass and loudness.

To use the equaliser:

1. Press .
2. Press the **Select** buttons to choose 'Audio'.
3. Choose an equaliser setting:
 - To choose an equaliser setting, press the **Select** buttons.
 - To use custom settings, press the **Select** buttons to choose 'Custom'. Then press the **Select** buttons to change the treble, bass and loudness.

Display settings

Changing the information displayed on the screen

You can change the information that is displayed on the screen when you are listening to the radio. For example, you can display scrolling information about the current radio station.

To change the information displayed on the screen:

1. Press .
2. Press the **Select** buttons to choose 'Display'.
3. Press the **Select** buttons to choose 'Info'.
4. Press the **Select** buttons to choose the information to display.

Changing the screen brightness

Your Evoke H3 has a light sensor, which adjusts the screen brightness based on your surroundings. You can also manually change the screen brightness.

To help save energy, you can dim the screen after 10 seconds of inactivity.

To change the brightness of the screen when switched on:

1. Press .
2. Press the **Select** buttons to choose 'Display'.
3. Press the **Select** buttons to choose 'Backlight'.
4. Press the **Select** buttons to choose 'On Level'.
5. Press the **Select** buttons to choose a brightness level. To make your screen brighter, choose a higher number. To automatically set the screen brightness, choose 'Auto'.

To dim the screen after 10 seconds of inactivity:

1. Press .
2. Press the **Select** buttons to choose 'Display'.
3. Press the **Select** buttons to choose 'Backlight'.
4. Press the **Select** buttons to choose 'Duration'.
5. Press the **Select** buttons to choose 'Timed'.

To change the brightness of the screen when dimmed:

1. Press .
2. Press the **Select** buttons to choose 'Display'.
3. Press the **Select** buttons to choose 'Backlight'.
4. Press the **Select** buttons to choose 'Dim Level'.
5. Press the **Select** buttons to choose a brightness level. To make your screen brighter, choose a higher number.

Clock settings

Setting the time and date

Your Evoke H3 can use FM and digital radio signals to set the time and date automatically. If the time and date do not update automatically, you can set them manually.

To set the time and date automatically:

1. Press .

2. Press the **Select** buttons to choose 'Clock'.
3. Press the **Select** buttons to choose 'Auto Update'.
4. Press the **Select** buttons to choose how to set the time and date.

To set the time and date manually:

1. Press .
2. Press the **Select** buttons to choose 'Clock'.
3. Press the **Select** buttons to choose 'Set Time/Date'.
4. Press the **Select** buttons to set the date.
5. Press the **Select** buttons to set the time.

Changing the time format

To change the time format:

1. Press .
2. Press the **Select** buttons to choose 'Clock'.
3. Press the **Select** buttons to choose 'Set 12/24 Hour'.
4. Press the **Select** buttons to choose the time format.

Changing the date format

To change the date format:

1. Press .
2. Press the **Select** buttons to choose 'Clock'.
3. Press the **Select** buttons to choose 'Set Date Format'.
4. Press the **Select** buttons to choose the date format.

Changing the language

You can change the language of menus and settings.

To change the language:

1. Press .

2. Press the **Select** buttons to choose 'Settings'.
3. Press the **Select** buttons to choose 'Language'.
4. Press the **Select** buttons to choose a language.

Resetting to factory settings

A factory reset removes all stored presets, alarms, timers and settings on your Evoke H3.

Note: You cannot undo a factory reset.

To reset to factory settings:

1. Press .
2. Press the **Select** buttons to choose 'Settings'.
3. Press the **Select** buttons to choose 'Factory Reset'.
4. Press the **Select** buttons to choose 'Yes'.
Your Evoke H3 resets to factory settings and then restarts.

Updating the software

Pure may provide software updates to your Evoke H3. To check for available software updates, visit support.pure.com.

Tip: To be contacted when software updates are available, you can register your product at pure.com/register.

To check the current software version:

1. Press .
2. Press the **Select** buttons to choose 'Settings'.
3. Press the **Select** buttons to choose 'Software Version'.

To update the software:

1. Use a Micro USB cable to connect your Evoke H3 to your computer.
2. Follow the instructions provided with the software update file.

Using a ChargePAK

About ChargePAKs

A ChargePAK is a rechargeable battery pack that allows you to listen to your music anywhere. When your Evoke H3 is connected to a power outlet, it charges the ChargePAK. You can then disconnect your Evoke H3 from the power and take your music with you.

Inserting a ChargePAK

Note: Your Evoke H3 is only compatible with a Pure ChargePAK B1. Do not use any other batteries or ChargePAK models with your Evoke H3.

To insert a ChargePAK:

1. Switch your Evoke H3 off and disconnect it from the power supply.
2. At the back of your Evoke H3, press the two clips on the battery cover to remove it.
3. Insert the ChargePAK connector into the socket in the battery compartment.
4. Insert the ChargePAK into the battery compartment with the Pure label facing you.
5. Replace the battery cover.
6. Connect your Evoke H3 to the power supply.
The ChargePAK starts charging. If the ChargePAK is new or has not been used for a long time, we recommend you charge it for at least 24 hours.

Note: When the ChargePAK is charging, it is normal for it to get warm. The efficiency of the ChargePAK may decrease over time.

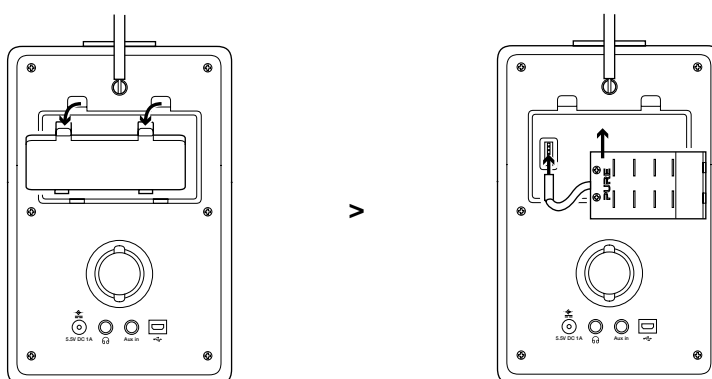

Troubleshooting

Problem	Solution
I can't hear any sound	Use the Volume dial to turn the volume up. For digital radio, perform an autotune. Read more on page 9. For Bluetooth or auxiliary devices, check a device is connected. Turn the volume up on the connected device.
The screen is very dark	Remove any obstructions from in front of the speaker. There is a light sensor behind the speaker grill. Turn up the screen brightness. Read more on page 16.
I can't find an FM or digital radio station	Adjust your aerial and check it is fully extended. Move your radio to another location. For digital radio, perform an autotune. Read more on page 9. For FM radio, try using mono reception to improve the signal strength. Read more on page 10.

PURE

www.pure.com

www.facebook.com/pure

106UH_02